

EC-C1212 CSP LED Strip

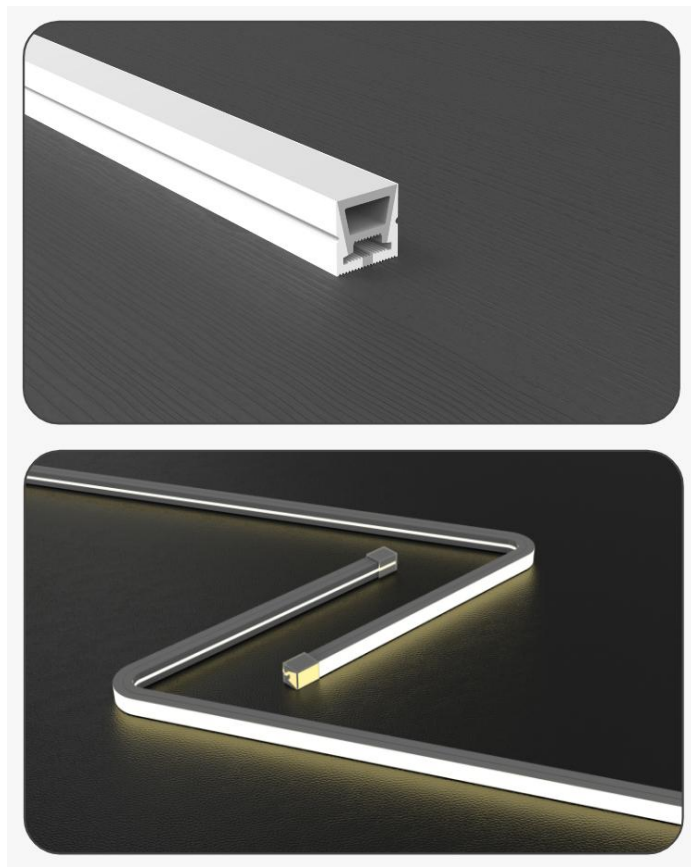

Application Environment:
Indoor
Outdoor

Description

LED strip lights for indoor or outdoor applications, such as under-cabinet lighting, coves, landscapes, vehicles, and more. Choose 24V or 12V LED tape lights of any color, brightness, or length, and install them using a range of compatible accessories

Features

- The appearance is simple and fashionable, and the decoration is strong;
- The luminescence is even and soft, showing the city's glamorous style;
- The electronic components are completely covered in silicone glue, and the insulation and water resistance can reach IP 66, which is safe to use;
- The silicone rubber lamp belt is soft and can be bent into different shapes at will, which is convenient to use;
- Widely used in decoration and lighting of buildings, bridges, roads, gardens, courtyards, floors, ceilings, furniture, cars, advertisements, signs, signs, etc.

Basic Specifications

Color	2700K/3000K/4000K/5000K/ 6000K/Red light/green light/ice blue light
Working Voltage	DC24V
Max. Power Consumption	9W/1M
Light Source	240pcs LEDs/1M
Length	1m or 5m/roll
CRI	80
Control	ON/OFF
Source Life	50,000h
Diffuser	Silicone(Transparent, Opal,)
Weight	145g/meter

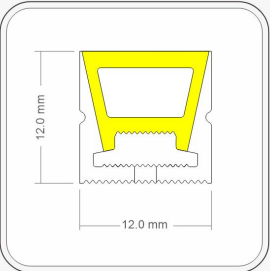
Dimensions	 <p>Production cross section</p>
Installation	Clip
Working Temperature	-30°C to 50°C
Storage Temperature	-40°C to 70°C
Protection Rating	IP66
Beam Angle	120°

Light Intensity Distribution

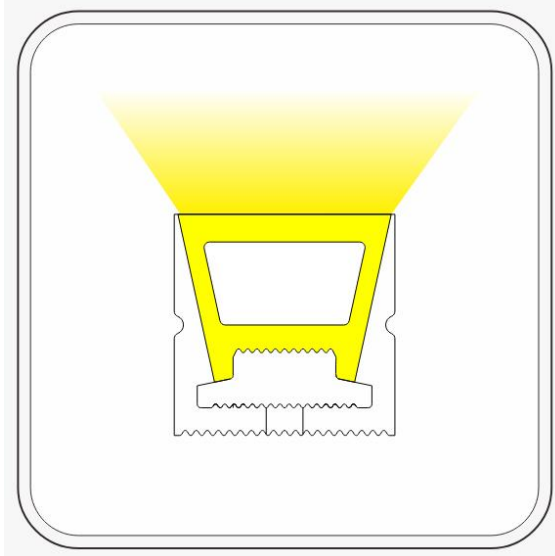

120° luminescence

Mounting Clip Accessories (Optional for choose)



Silicone tail plug



Straight-out plug



Aluminum alloy mounting buckle



Side plug (optional)

Installation Diagram



Cut at the position marked by the black strip on the back of the light strip. Do not cut between other positions to avoid damage to the light strip.



Schematic diagram after cutting.



Pass the wiring through the plug.



Press red positive and black negative to solder the wires on the bare board.

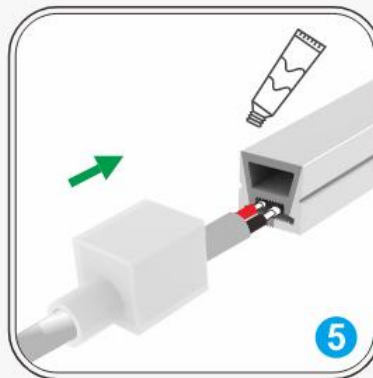

Apply glue to the port and cover the light bar with the plug in the direction.



Seal the outlet with glue in a circle to ensure that the plug is dry and installed firmly.



Follow the same steps to install the side-out plug.

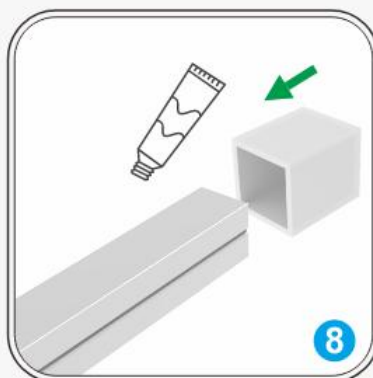

Prepare the tail plug, apply glue to the port, and cover the tail plug with the light bar according to the arrow.



The tail plug installation is complete.

Precautions

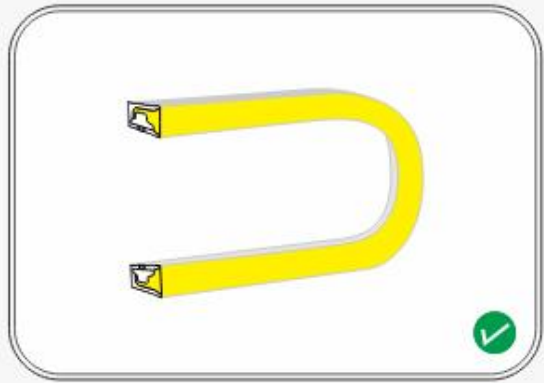

With the backlight facing up, the light bar can be bent laterally.

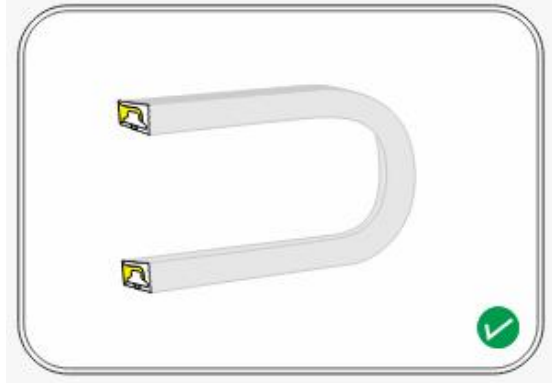

With the luminous facing upward, the lamp strip can be bent laterally

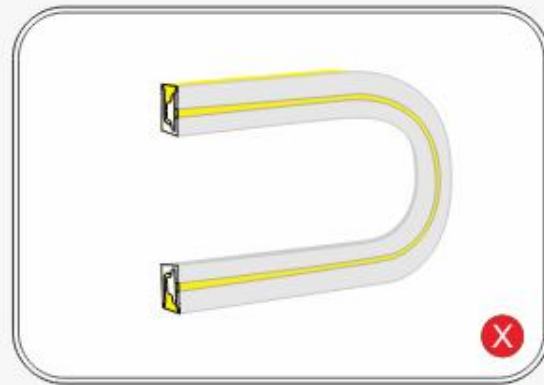

Do not bend the lamp strip up and down, avoid damage to the lamp strip.

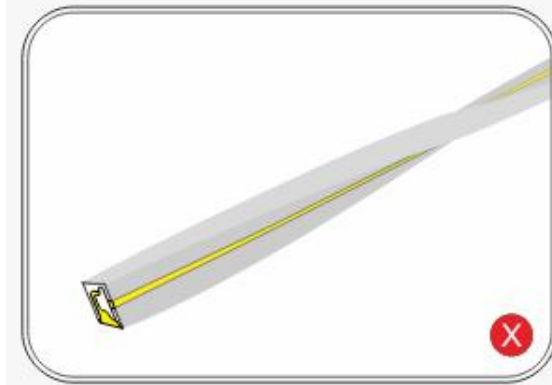

Do not twist and bend the light bar, avoid damage to the light bar.



1: This product is a low-voltage product and available for using AC - DC Switch power. Do not connect directly to AC 220V, otherwise it will burn the LED strip.

2: Please read the product specification in detail before using this product, and ask professionals to install it to ensure safe use.